

- de Montageanleitung
Standgerät
- en Installation instructions
Free-standing appliance
- fr Notice de montage
Appareil indépendant
- it Istruzioni per il montaggio
Apparecchio indipendente
- nl Montagehandleiding
Vrijstaand apparaat
- da Monteringsvejledning
Gulvmodel
- no Monteringsanvisning
Frittstående apparat
- sv Monteringsanvisning
Fristående apparat
- fi Asennusohjeet
Vapaasti sijoitettava laite
- es Instrucciones de montaje
Aparato de libre instalación
- pt Instruções de montagem
Aparelho Solo
- el Οδηγίες τοποθέτησης
Ανεξάρτητη συσκευή
- tr Montaj kılavuzu
Solo cihaz
- et Paigaldusjuhend
Eraldiseisev seade

- cs Montážní návod
Volně stojící spotřebič
- pl Instrukcja montażu
Urządzenie wolnostojące
- hu Szerelési útmutató
Magánálló készülék
- ru Инструкция по монтажу
Напольный прибор
- ro Instrucțiunea de montaj
Aparat independent
- sk Návod na montáž
Voľne stojací spotrebič
- sl Navodilo za montažo
Samostojna naprava
- lt Montavimo instrukcija
Pastatomas prietaisas
- lv Montāžas pamācība
Brīvi stāvoša ierīce
- kk Орнату жөнүндө нұсқаулар
Едендік құрылғы
- uk Інструкція з монтажу
Підлоговий прилад
- uz Yig'ish qo'llanmasi
Mustahkam o'rnatilgan asbob
- ar إرشادات التركيب
جهاز للنصب المنفرد
- fa راهنمای مونتاژ
دستگاه استاندارد
- he הוראות הרכבה
מכשיר ניצב

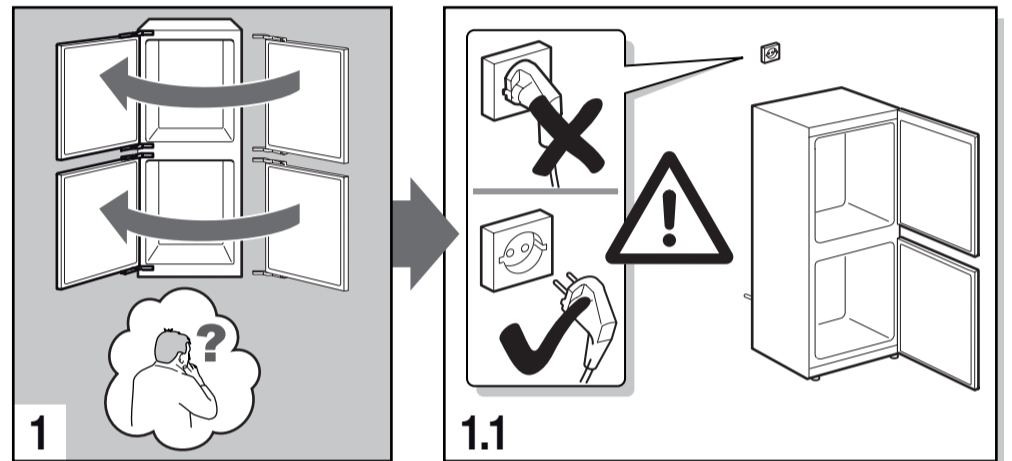

8001 029 167 (9511)

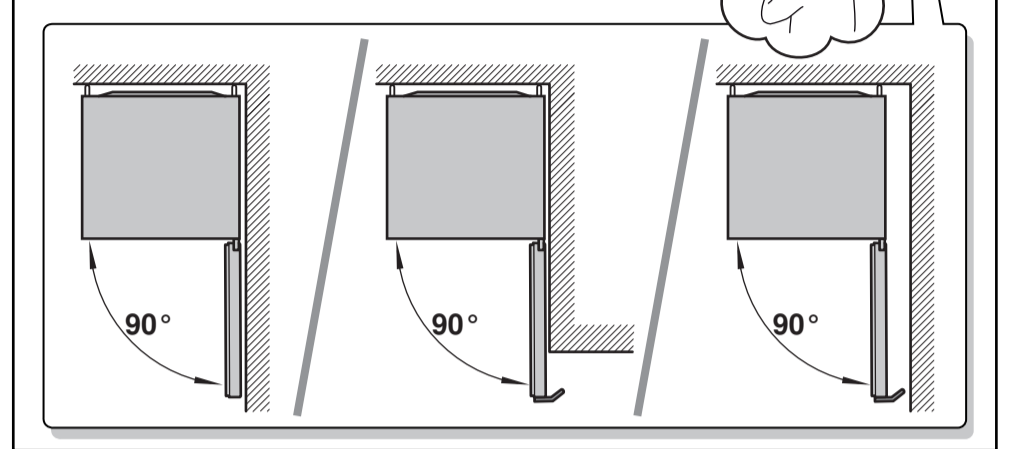
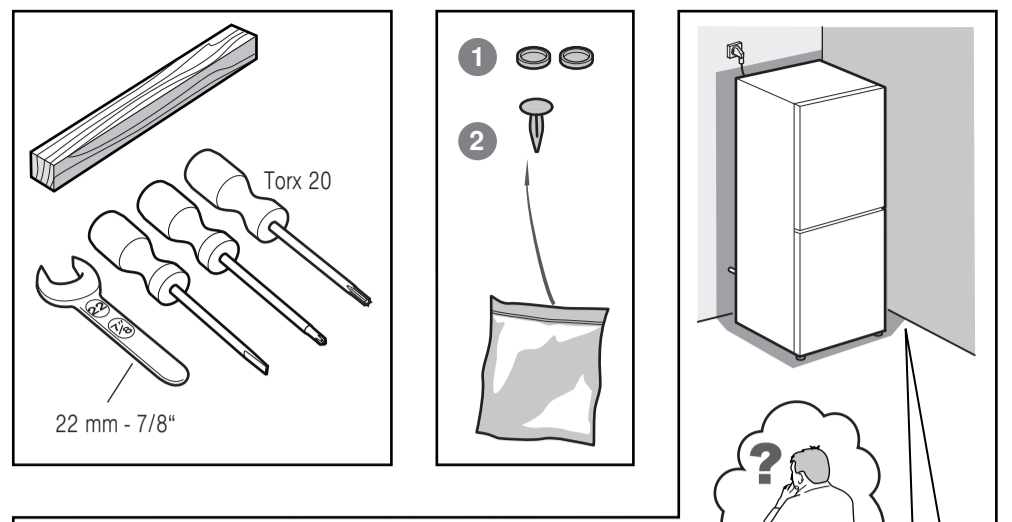